



ASSEMBLY INSTRUCTIONS INSTRUCCIONES DE ENSAMBLE

MADEIRA TABLE / RECTANGULAR MESA MADEIRA / RECTANGULAR



/ Assembly Parts / Piezas de Ensamble

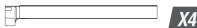

X4

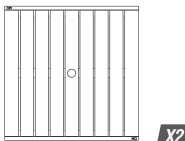

X2

Bristol screw
Tornillos cabeza bristol



X16



X16



X16



X2

Cross Screws
Tornillos de estrella



X4



X8



X2

L Key
Llave bristol



X1

Double hex key
Llave hexagonal doble



X1

Place side by side the table ends with perforations
Enfrentar los extremos de la mesa con perforaciones

1

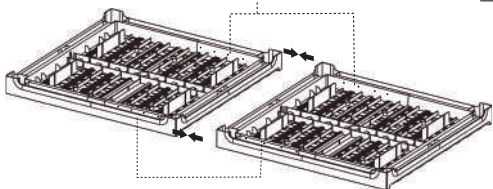

x2 Repeat this step with both metal plates and joints
Repita este paso con las dos platinas metálicas y uniones

2

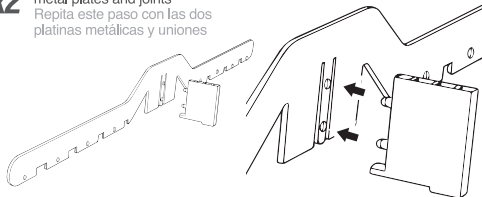

Be sure to align the metal plates with covers and holes on the sides of the pieces for later screws installation.

Asegurese de alinear las platinas metálicas con las cubiertas y los orificios en los laterales de la misma para posteriormente instalar los tornillos.

3

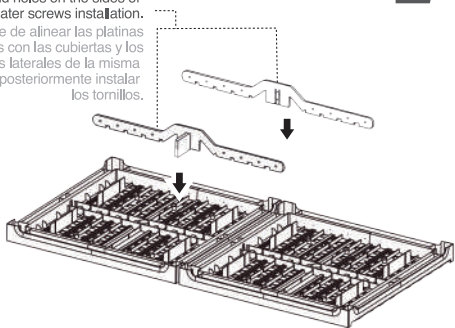

4

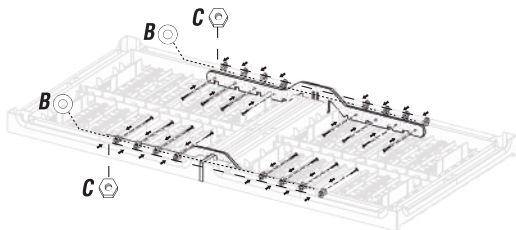

Secure the screws with
the included tools
Utilice la herramienta incluida
para asegurar los tornillos



5

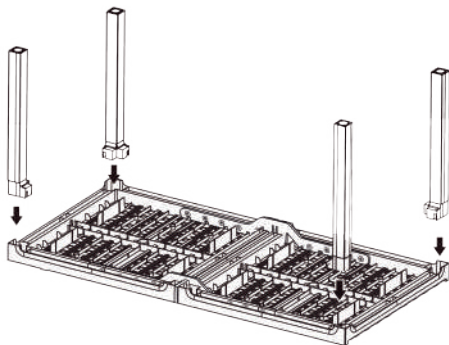

6

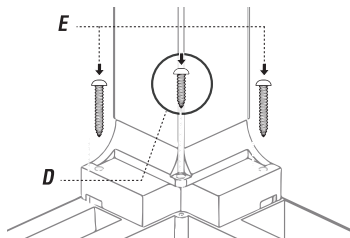

VIEW
ASSEMBLY
VIDEO

VER
VIDEO
DE ENSAMBLE



MADEIRA

IMPORTANT: Please contact Customer Service if you have any problems or discover any missing parts.
IMPORTANTE: Sírvase contactar con nuestro Servicio al Cliente por cualquier problema o pieza que pudiera faltar. www.plasticosmq.com.co