

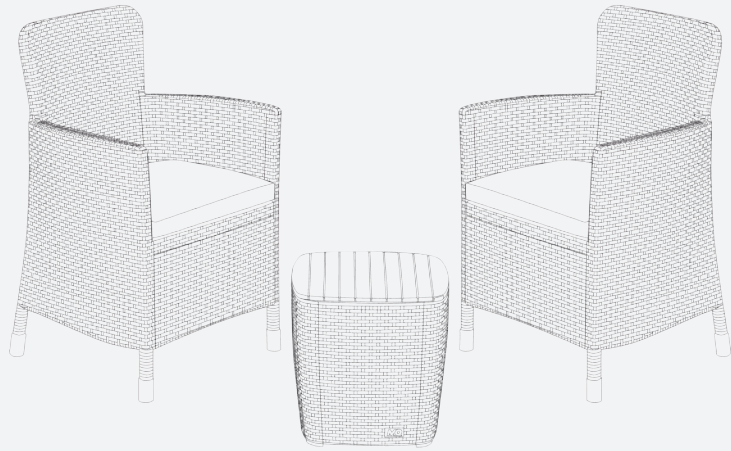

SALA ESTAR / PATIO SET
·C|A|P|R|I·

ASSEMBLY INSTRUCTIONS
INSTRUCCIONES DE ENSAMBLE



www.plasticosmq.com.co

/ Assembly Parts / Piezas de Ensamble

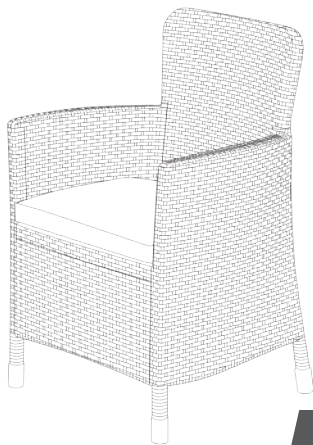

x2



Video Version / Versión Video

Required Tool / Herramienta Requerida
*Included / Incluida

Screw Wrench / Llave para tornillos

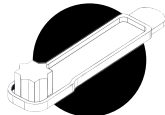

x1

Includes 1 replacement screw
Incluye 1 tornillo de repuesto

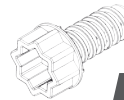

x1

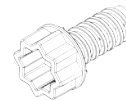

x24



x12



x8

·C|A|P|R|I·
SILLÓN / CHAIR

/ 2 Cushions included / Incluidos 2 cojines

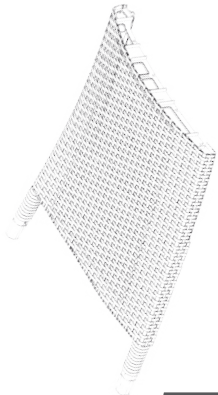

RA x2



RA-CO x2

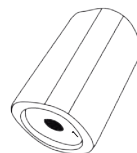

1 x2

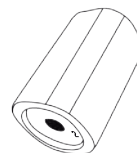

2 x2

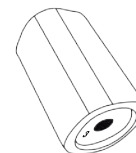

3 x2

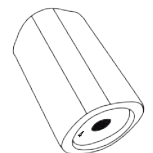

4 x2

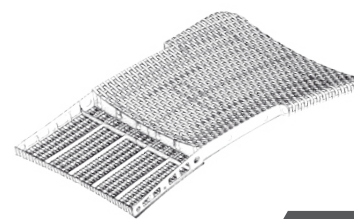

BK x2

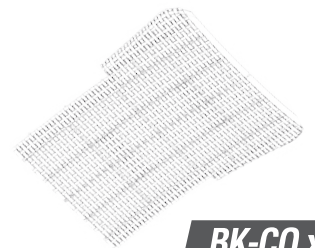

BK-CO x2

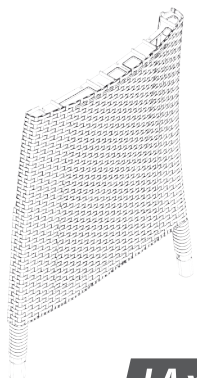

LA x2



LA-CO x2

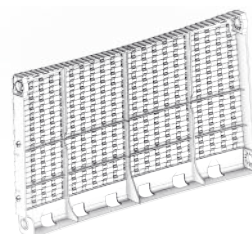

FB x2



SE x2

STEP / PASO

1

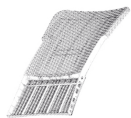

BK x1



SE x1

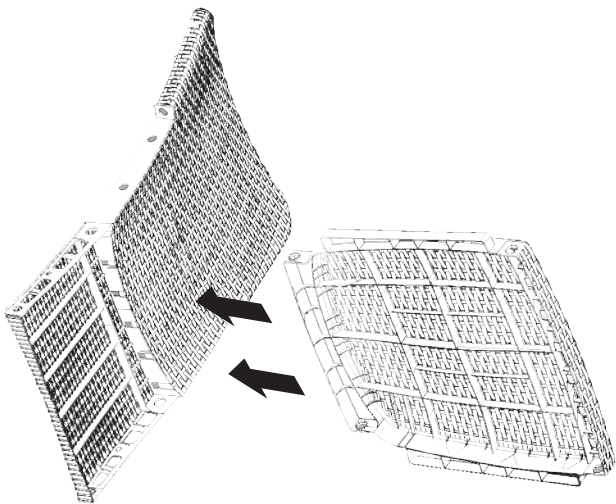

STEP / PASO

2



FB x1

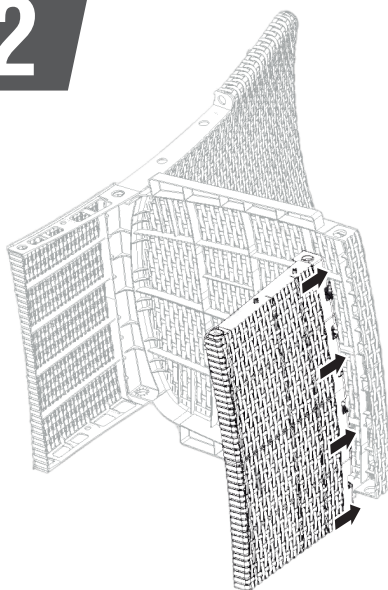

STEP / PASO

3



x1



x3

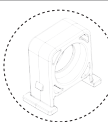

x2

REPEAT THIS STEP WITH THE ANOTHER ARM OF THE CHAIR
REPITE ESTE PASO CON EL OTRO BRAZO DEL SILLÓN

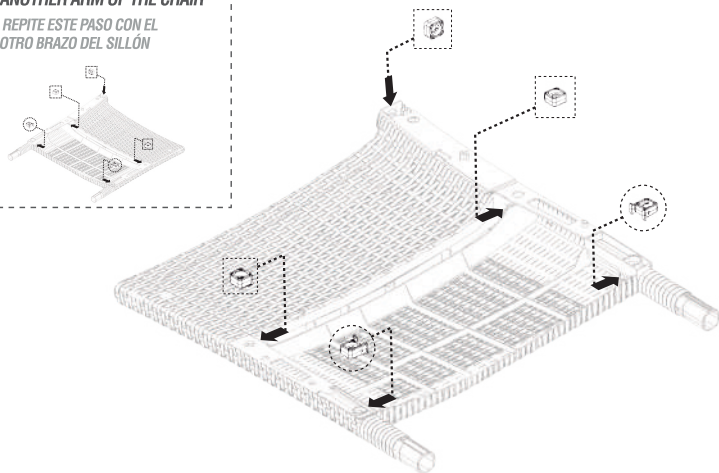

STEP / PASO

4



x1

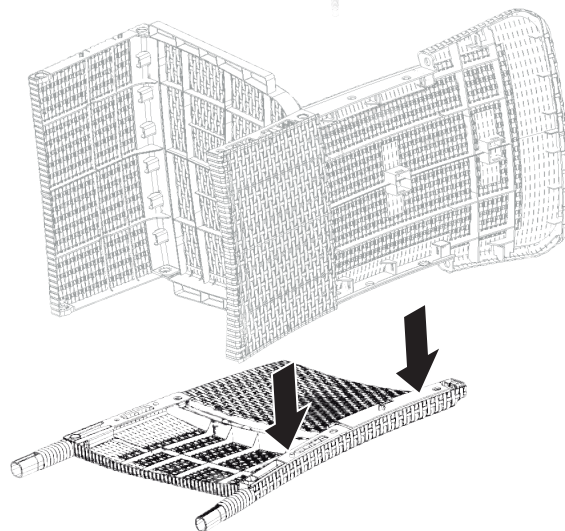

STEP / PASO

5

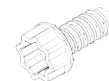
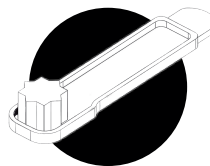

x6

Use the included tool to secure the screws
Utilice la herramienta incluida para asegurar los tornillos

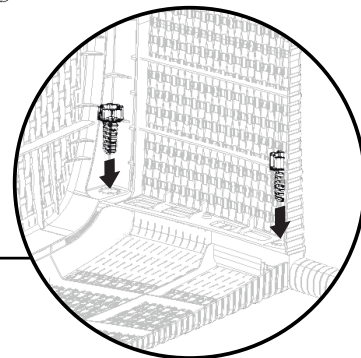
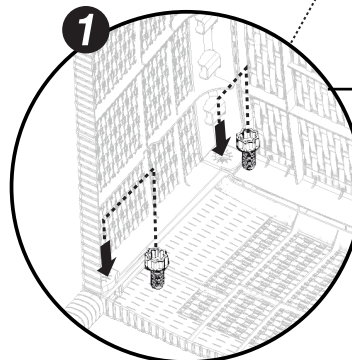
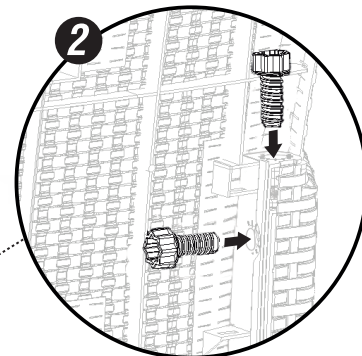
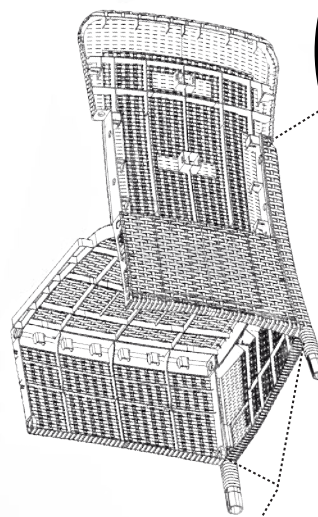

STEP / PASO

6

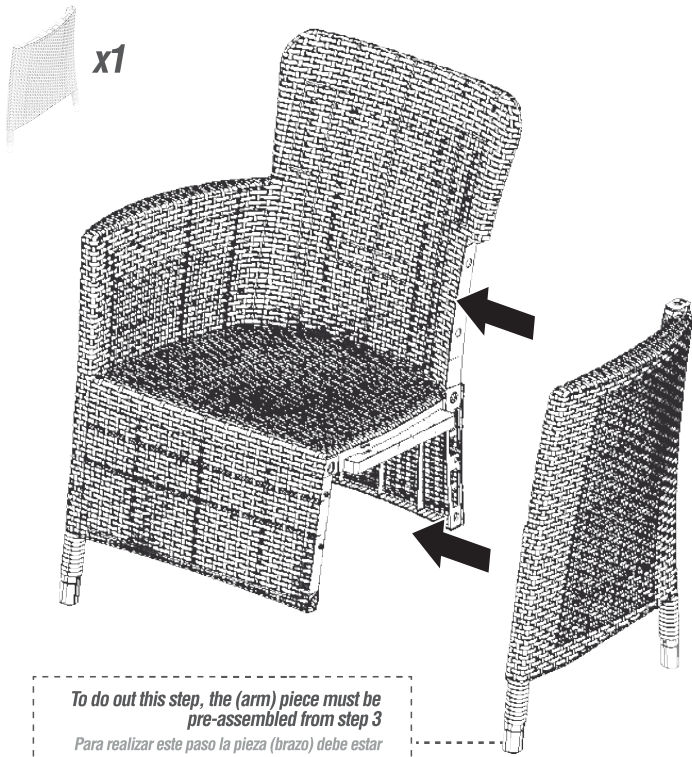

To do out this step, the (arm) piece must be pre-assembled from step 3
 Para realizar este paso la pieza (brazo) debe estar pre-ensamblada desde el paso 3

STEP / PASO

7

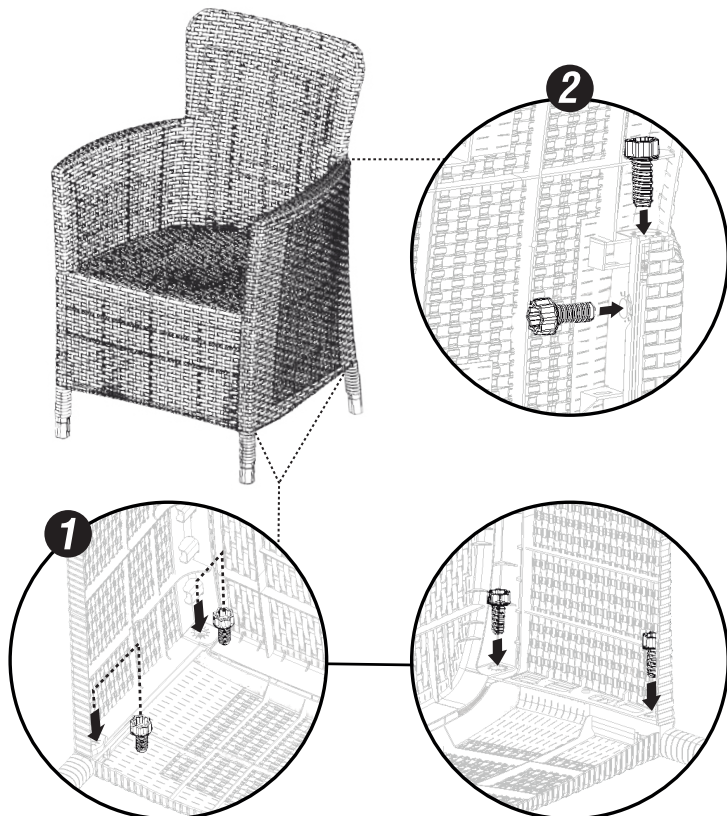
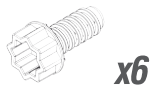

BK-CO x1

STEP / PASO

8

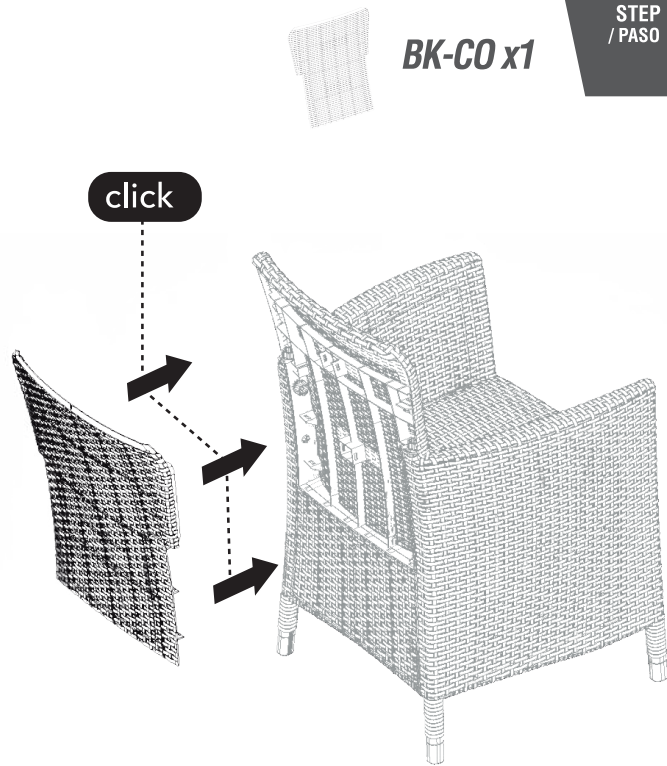

Check the identification number
 Verifique el número de identificación

1-2-3-4



STEP / PASO

9

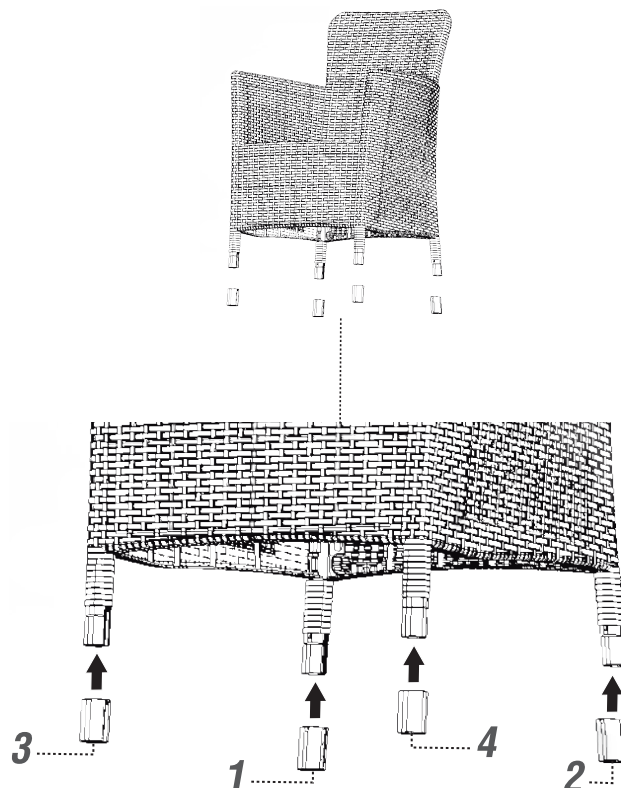



Video Version / Versión Video



·C|A|P|I|R|I·

MESA DE CENTRO / CENTER TABLE

ASSEMBLY INSTRUCTIONS

INSTRUCCIONES DE ENSAMBLE

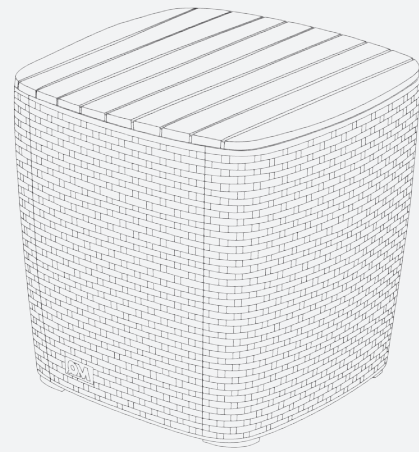

x1

www.plasticosmq.com.co

/ Assembly Parts / Piezas de Ensamble

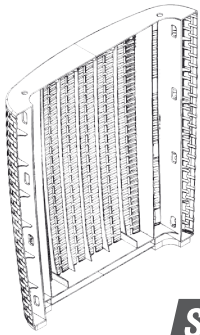

SA x2

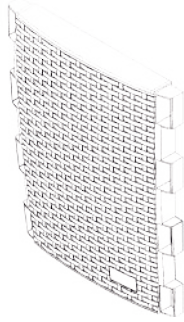

SB x2

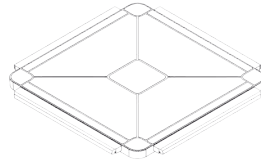

FL x1

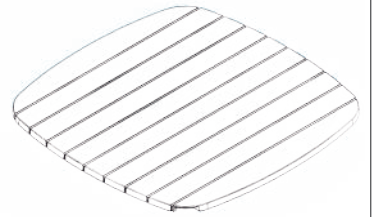

CA x1

STEP / PASO 1

SA x2



SB x2

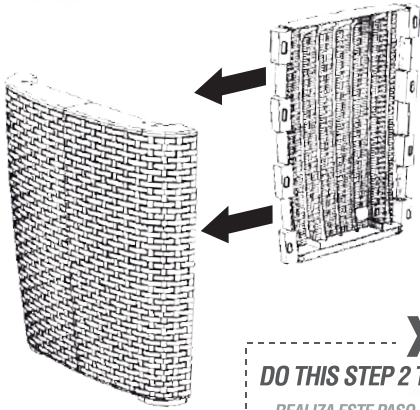

x2
DO THIS STEP 2 TIMES
REALIZA ESTE PASO 2 VECES

STEP / PASO 3

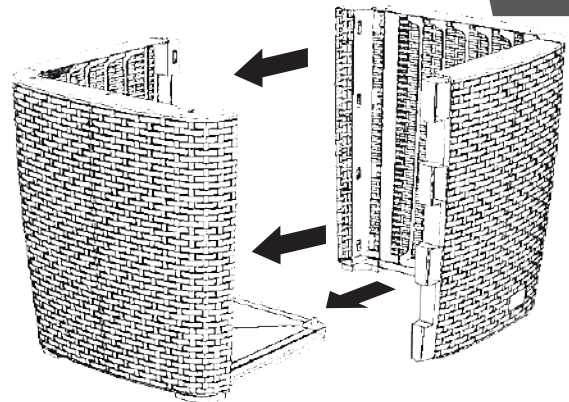

STEP / PASO 2

FL x1

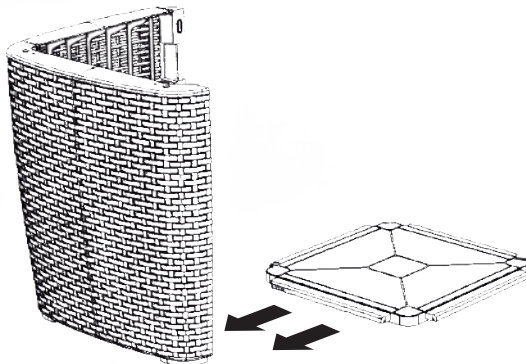
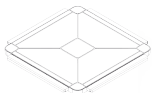

STEP / PASO 4

CA x1

